

# PROFIBUS DP

## ES-FLOW Hook-up diagram

### PROFIBUS DP connection

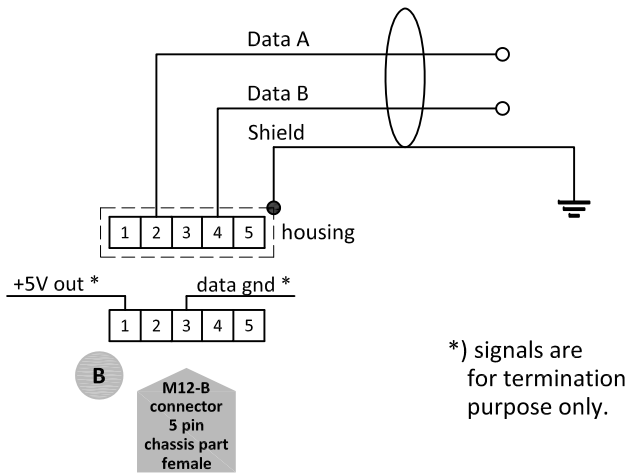

### Model key explanation

For other explanation see 9.16.196

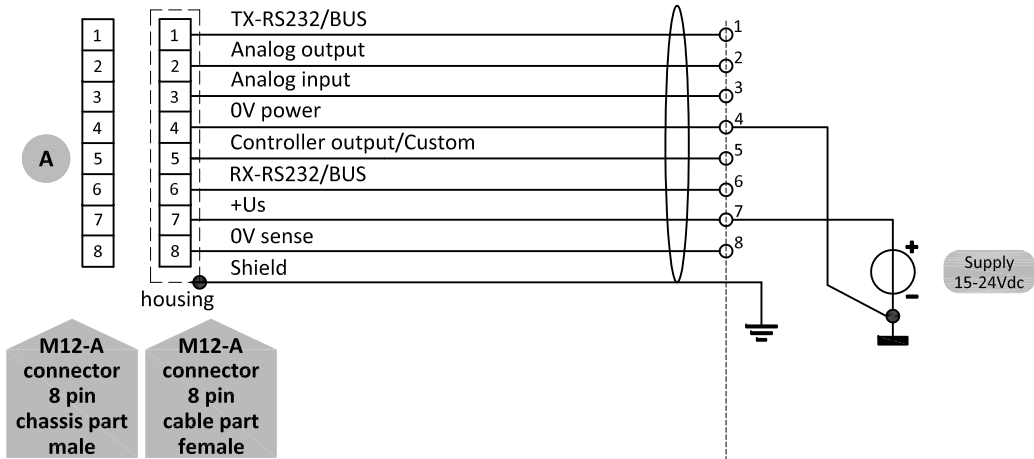
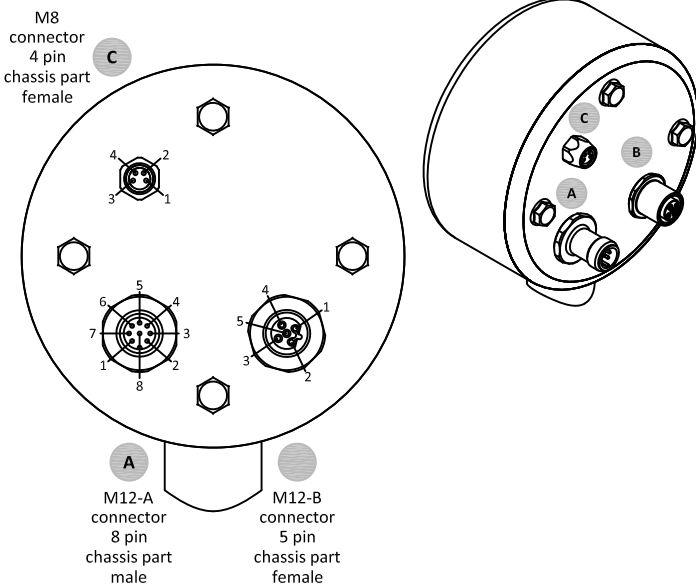
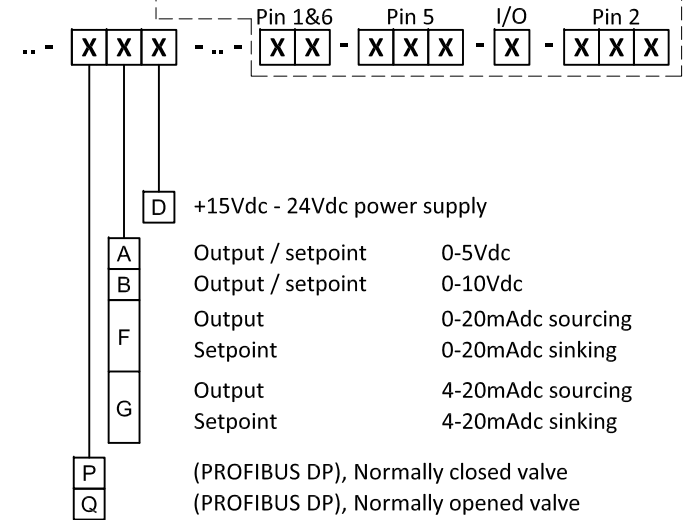

Note:  
When using a field bus or RS232, it is not possible to operate the instrument by using the setpoint signal of the analog M12 connector without changing the value of parameter "control mode".  
See doc.nr. 9.17.116 for more details.  
Do not connect an external valve to instruments, set as meter.