

DeviceNet connection

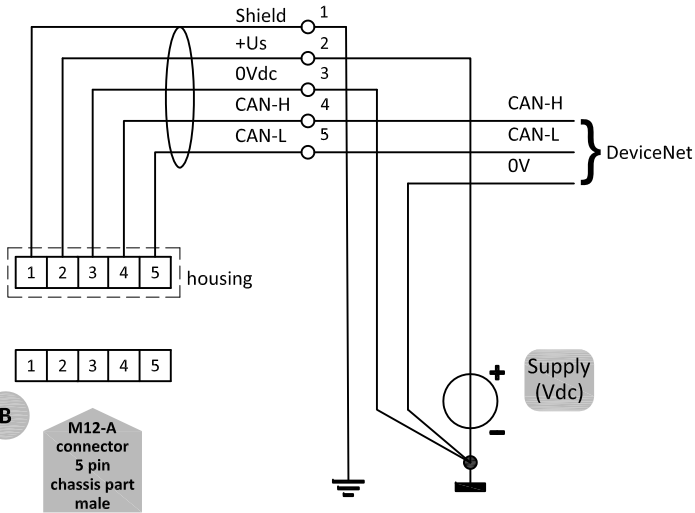

Model key explanation

For other explanation see 9.16.196

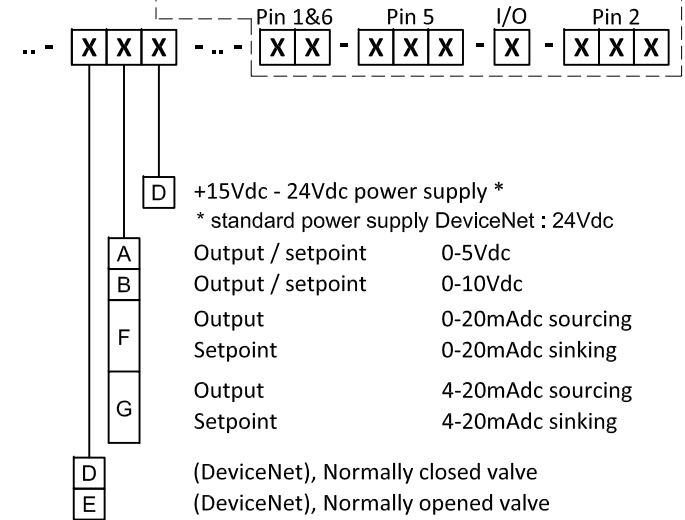

POWER SUPPLY WARNING



Do not power the instrument simultaneously from two different power sources (e.g. bus connection and Plug-in Power Supply). Doing so will damage the printed circuit board irreparably.

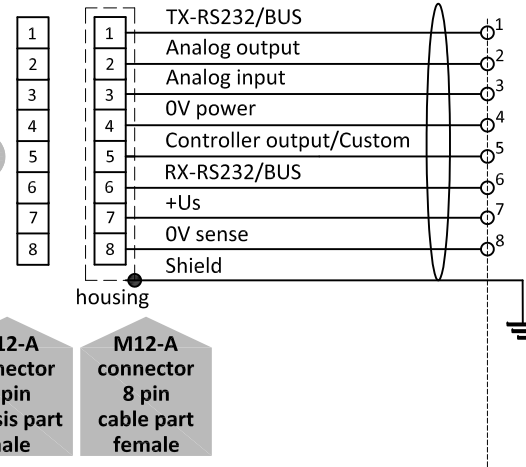
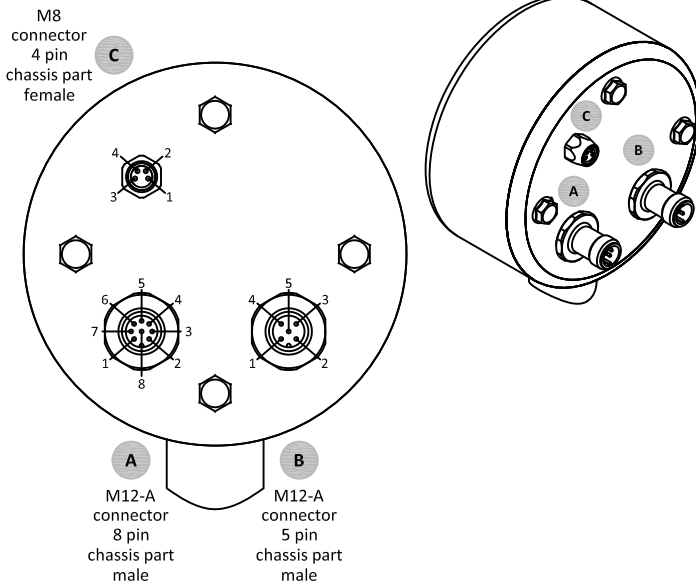

Note:

When using a field bus or RS232, it is not possible to operate the instrument by using the setpoint signal of the analog M12 connector without changing the value of parameter "control mode". See doc.nr. 9.17.116 for more details.
Do not connect an external valve to instruments, set as meter.

Note:

Powering a single instrument is possible by the M12 connector. Please consult 9.16.156 for a connection diagram.